

## 32" Grand Grab Bar with Contemporary Round Flange

Model #: C16-32-



### FEATURES:

- ADA compliant when properly installed
- Complements Contempo & Astor collections
- Covers standard 3" flange on existing stainless steel grab bars
- No need to re-tile in retro-fit applications
- 1 1/4" diameter
- For large quantity custom lengths contact [hospitality@jaclo.com](mailto:hospitality@jaclo.com)
- Grab bars 24" or longer are NOT AVAILABLE in PG or SG. For large quantity orders, please contact [hospitality@jaclo.com](mailto:hospitality@jaclo.com)

### AVAILABLE FINISHES:

Polished Chrome (PCH)	Satin Chrome (SC)	Bronze Umber (BU)
Satin Nickel (SN)	Pewter (PEW)	Caramel Bronze (CB)
Polished Nickel (PN)	Antique Brass (AB)	Antique Copper (ACU)
Oil-Rubbed Bronze (ORB)	Polished Brass (PB)	Polished Copper (PCU)
Vintage Bronze (VB)	Satin Brass (SB)	Matte Black (MBK)
Satin Gold (SG)	Polished Gold (PG)	Black Nickel (BKN)
White (WH)	Unlacquered Brass (ULB)	Satin Cooper (SCU)
Almond (ALD)	Amber (AMB)	Azure Blue (AZB)
Coral (COR)	Mint Green (GRN)	Stone Grey (GRY)
Lilac (LAC)	Light Blue (LBL)	Limon (LIM)
Plum (PLM)	Pink (PNK)	Red (RED)
Graphite (GPH)	Aged Unlacquered Brass (AUB)	

### SPECIFICATION DRAWING:

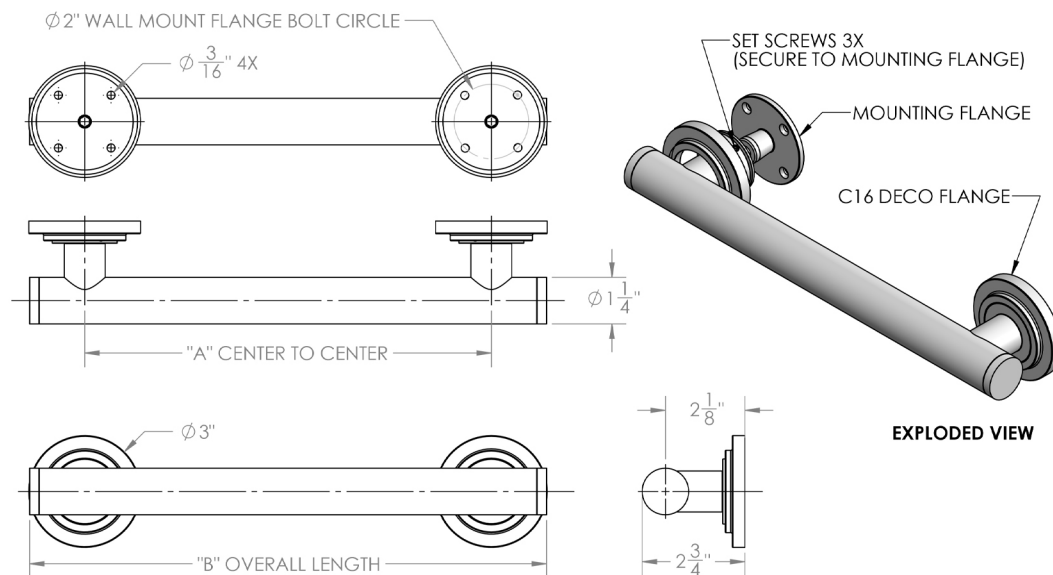

Part #	A	B
C16-12	12"	13 7/8"
C16-16	16"	17 7/8"
C16-18	18"	19 7/8"
C16-24	24"	25 7/8"
C16-32	32"	33 7/8"
C16-36	36"	37 7/8"